

BASIC INFORMATION:

- QuietLok® multilayer modular products are intended for interior commercial use only and are suitable for above-grade, on-grade and below-grade applications. However, QuietLok® should not be installed in locations where the substrate beneath the building structure is exposed to the elements.
- QuietLok® multilayer modular products are to be installed as a floating floor system and must be free to move as a whole sheet in response to changes in temperature. It must not be glued, nailed, or fastened to the substrate, walls or fixed to any part of the building structure. Install permanent fixtures such as walls, partitions, shelving, cabinets, displays, counters, tracks for transition profiles and similar items first, then fit QuietLok® around them, leaving a space for expansion and contraction. Fill expansion spaces around potentially wet areas with premium waterproof 100% silicone sealant. Always remove standing water, pet urine, and other liquids promptly.
- Direct sunlight may cause QuietLok® multilayer modular products to fade or to expand, causing the floor to buckle or separate. Protect QuietLok® from direct sunlight using window treatments or UV tinting on windows. QuietLok® multilayer modular products are not recommended for use in sun rooms.
- QuietLok® multilayer modular flooring is a waterproof floating floor, but it should not be used to seal an existing floor from moisture. It cannot inhibit the growth of mold or prevent structural problems associated with, or caused by flooding, excessive moisture, alkalies in the substrate, or conditions arising from hydrostatic pressure. Regardless of location, always remove standing water, urine and other liquids promptly. Jobsite moisture issues must be addressed and corrected prior to installation.



QL PROFILES - WINDOM INSTALLATION INSTRUCTIONS

EVALUATE THE JOB SITE:

Exterior

Damage caused by water and high humidity should be addressed prior to installing QuietLok® multilayer modular flooring.

- Examine the driveway, parking areas, and landscaping surrounding the building. Be sure that they slope and direct water away from the foundation.
- Inspect gutters, down spouts and drains for blockage. Remove clogs caused by leaves, dirt and debris, allowing runoff to flow freely away from the foundation.
- Check crawl spaces for cross-ventilation air vents equaling at least 1.5% per 100 square feet (9.3 square meters) of floor space. Crawl spaces should measure a minimum of 18 inches (46.0 cm) high and should be insulated according to the latest building code requirements. The ground should be covered with a minimum 6-mil vapor barrier.

Interior

Jobsite moisture issues must be addressed and corrected prior to installation.

- Examine the installation site for leaky plumbing, including leaks from water heaters, wet bars, soda fountains, or any other water-bearing fixtures or pipes.
- Inspect substrates for levelness. They must be clean, smooth, dry, structurally sound, and flat within $\frac{3}{16}$ " (5.0mm) within a 10-foot (3.0 meters) radius. The substrate should not slope more than 1 inch (25.0mm) per 6 feet (1.8 meters) in any direction.
- QuietLok® requires testing of concrete substrates for moisture and pH before installing QuietLok® multilayer modular flooring. Test results should not exceed 85% relative humidity (RH). The Calcium Chloride Test for moisture should be no more than 8 lbs per one-thousand square feet in 24 hours MVER (Moisture Vapor Emission Rating), and pH tests for alkalinity levels should register between 7 and 9.
- QuietLok® requires testing of wood substrates for moisture. Obvious signs of moisture issues include warping, peaking, degradation of the integrity of the substrate, rusted fasteners, and rusted floor registers. Even if obvious signs are not present, the material should be tested using a professional moisture meter; moisture levels should not exceed 14%.

ATTENTION: Mold and mildew grow only in the presence of moisture. Jobsite moisture issues must be addressed and corrected prior to installation. Please visit www.epa.gov/mold for information about safely preventing and removing mold, mildew and other biological pollutants.



IDENTIFY YOUR SUBSTRATE:

Approved Substrates

- Concrete
 - QuietLok® multilayer modular flooring is waterproof, but jobsite moisture issues must be corrected before installation begins to prevent serious damage to the substrate and surrounding structure, and to discourage the growth of mold and mildew. Concrete substrates should be prepared in accordance to the most current version of ASTM F710 (Standard Practice for Preparing Concrete Floors to Receive Resilient Flooring). Concrete substrates must be clean, smooth, dry, structurally sound, and flat within 3/16" (5.0mm) within a 10-foot (3.0 meter) radius. The substrate should not slope more than 1 inch (25.0mm) per 6 feet (1.8 meters) in any direction. Moisture and alkalinity tests should be performed on all concrete substrates regardless of grade level or age of slab. Perform either ASTM F2170 In-Situ Relative Humidity (RH) test or ASTM F1869 Calcium Chloride Moisture Test (MVER: Moisture Vapor Emission Rating). Perform pH test per ASTM F710 to determine alkalinity of the slab. RH Test results should not exceed 85% relative humidity. The Calcium Chloride Test for moisture should measure no more than 8lbs per one-thousand square feet in 24 hours MVER, and pH tests for alkalinity levels should register between 7 and 9. Electronic meter testing is not considered a replacement for a Calcium Chloride Test or Relative Humidity Test. All moisture tests should be conducted prior to installation to ensure that moisture is at recommended levels. Follow current ASTM F710 guidelines. QuietLok® highly recommends that substrate moisture and pH testing are conducted by an ICRI (International Concrete Repair Institute) tier 2 certified technician.
- Radiant Heat
 - Radiant heating systems must be cast 1/2-inch (12.7mm) below the surface of the concrete slab, and should be operating at least 2 weeks before installing QuietLok® multilayer modular flooring. Set the temperature of the radiant heating system to 68°F (20°C) 48 hours before, during, and 72 hours after installation. The temperature of the radiant heat floor may be increased gradually 72 hours after installation, but the surface temperature should never exceed 85°F (29°C). Contact the manufacturer of your radiant heating system for further recommendations.

IDENTIFY YOUR SUBSTRATE (CONT):

Approved Substrates (Cont)

- Plywood, OSB, Particleboard, and Chipboard
 - Wood substrates must be A.P.A. approved with a minimum grade of “BB” or “CC”. They must be clean, smooth, dry, structurally sound, and flat within 3/16” (5.0mm) within a 10-foot (3.0 meters) radius. The substrate should not slope more than 1 inch (25.0mm) per 6 feet (1.8 meters) in any direction. QuietLok® recommends performing moisture tests prior to installation to prevent serious damage to the substrate and surrounding structure, and to discourage the growth of mold and mildew. Moisture readings should never exceed 14% for plywood, OSB, particleboard and chipboard substrates. If moisture readings exceed 14%, it is advisable to correct moisture issues at the jobsite before installing.
- Tile, Terrazzo, Asbestos Tile, Resilient Tile, Non-cushion Sheet Vinyl, and Metal
 - Existing floors must be firmly attached to the structural floor. In order to prevent vertical deflection (movement) and potential damage to the integrity of the QuietLok® multilayer modular flooring, all substrates must be sturdy, sound, and flat within 3/16” (5.0mm) within a 10-foot (3.0 meters) radius. The substrate should not slope more than 1 inch (25.0mm) per 6 feet (1.8 meters) in any direction. Fill in grout lines on ceramic tiles, terrazzo, quarry tiles and similar floors with cementitious patching compound.

Non-Approved Substrates

Remove the floors noted below and remove old adhesive before installing QuietLok® multilayer modular flooring. Encapsulate adhesive and cutback residue.

- Carpeting/Carpet Pad, Cushion Back Sheet Vinyl, Engineered Hardwood Over Concrete, Floating Floors, Hardwood Over Concrete, Parquet Over Concrete, and Sleeper Substrates.

NOTE: Various Federal, State and Local government agencies have established regulations governing the removal of in-place asbestos-containing material. If you contemplate the removal of a resilient floor covering structure that contains (or is presumed to contain) asbestos, you must review and comply with all applicable regulations. Do not sand, dry sweep, dry scrape, drill, saw, bead blast, or mechanically chip or pulverize existing resilient flooring, backing, lining felt, asphalt “cut-back” adhesive, or other adhesive. These products may contain asbestos fibers and/or crystalline silica. Avoid creating dust. Inhalation of such dust is a cancer and respiratory tract hazard. Smoking by individuals exposed to asbestos fibers greatly increases the risk of bodily harm. Unless positively certain that the product is a non-asbestos containing material, you must presume it contains asbestos. Regulations may require that the material be tested to determine asbestos content. The RFCI’s Recommended Work Practices for Removal of Resilient Floor Covering are a defined set of instructions addressed to the task of removing all resilient floor covering structures. For further information, visit the Resilient Floor Covering Institute website at www.rfci.com

PREPARE THE JOB SITE:

Careful preparation is the key to outstanding results. All Trades Must Finish Before Installing QuietLok® multilayer modular flooring.

- Install Permanent Exterior Doors and Windows.
- Turn on HVAC at Least One Week Prior to Installation - Room temperature should be maintained between 50°F - 100°F (10°C - 38°C) at least 48 hours prior to installation.
- Allow all other Trades to Finish.
- Perform Recommended Moisture and pH Tests - See the "Identify Your Substrate" section of this manual for further information about suggested tests.
- Qualify and Prepare the Substrate - All substrates must meet all minimum standard building codes. Fill large cracks and voids with cementitious patching compound. In order to prevent vertical deflection (movement) and potential damage to the integrity of the QuietLok® flooring, all substrates must be clean, smooth, dry, structurally sound, and flat within 3/16" (5.0mm) within a 10-foot (3.0 meters) radius. The substrate should not slope more than 1 inch (25.0mm) per 6 feet (1.8 meters) in any direction.
- Remove Wall Base Moldings - Remove wall base moldings prior to installation. Leave appropriate expansion space between the edge of the flooring and walls or vertical surfaces.
- Fill Grout Lines - Fill grout joints when installing over existing ceramic tile or stone floors to obtain a smooth surface. Follow Substrate Flatness Tolerances per chart.
- Remove Non-approved Substrates.
- Remove or Encapsulate Old Adhesive - Old adhesives must be scraped up and left so that no ridges or puddles are evident and all that remains is a thin, smooth film. Then, encapsulate residue.
- Undercut Wood Door Casings - Wood door casings should be undercut so that QuietLok® flooring will fit neatly beneath them, concealing the expansion space.
- Cut Around Metal Door Casings - Do not cut metal door casings. Cut QuietLok® flooring around them, leaving the appropriate expansion space. After installation, fill the space with a coordinating premium waterproof 100% silicone sealant.
- Clean Up the Job Site - Remove all debris, sweep and vacuum the substrate. Smooth, non-porous floors should be damp-mopped after vacuuming and allowed to dry thoroughly before installing QuietLok® multilayer modular flooring. All dust must be removed prior to installation.

CHECK RUN NUMBERS AND MANUFACTURE DATE:

- Locate the run number on the short end of each carton and verify that all of the material for your job is from the same run. Minor shade variations within the same run number contribute to the natural look of QuietLok® flooring. To avoid noticeable shade variations, do not install material from different runs across large expanses. To determine manufacture date, locate the run number on the short end of the carton. It is the eight-digit number separated by decimal points. It's Day.Month.Year (ex. 29.10.2018).

INSTALLATION CONSIDERATIONS:

Subfloor Flatness Tolerances	3/6" in a 10' radius. Slope no more than 1" in 6'.
Vapor Barrier (6mil polyfilm)	Not Required
Is Underlayment Required	No - product includes an integral pre-attached pad.
Acclimation Requirements	48 Hours
Transition Requirements (T-mold) for Large Spaces	Required in rooms greater than 100' in any direction
Transition Requirements (T-mold) Doorways/ Thresholds	Required
Installation Over Existing Ceramic Tile Floor	Filling Grout Lines Required, Follow Substrate Flatness Tolerances
Glue Down Installation	Not Required/Not Recommended
Subfloor RH/MVER Recommendations	85% RH/8 lbs MVER
Radiant Heat	Approved – Substrate surface temperature not to exceed 85° F
3-Season/Non-Climate Controlled Environments	Not Recommended
Perimeter Expansion Requirements	3/8" around perimeter walls & heavy fixed objects such as cabinetry
Allowable Interior Environmental Conditions	50°F – 100°F / 40% – 60% RH
Definition of Waterproof	Structural integrity of flooring will not degrade due to contact with moisture/water

INSTALLATION:

1. Determine Room Layout - Measure and mark the center of the room on both the starting and ending wall. Snap a chalk line connecting the marks. This is your center line.
2. Set Working Lines - From the center line, measure 3 1/16" (78mm) to the left and to the right and mark along the line. Snap a chalk line connecting the marks down the entire length of the room. These are your working lines.
3. Prepare for Installation - QuietLok Profiles Window comes with A and B planks for installation. Separate out A & B Planks from 3-4 cartons at one time to ensure a mix of pattern and shade for best results. A planks have a grey pad and B planks have a black pad.
4. Set Starting the V - Working a few feet from the starting wall, set your starting V. Position the long side of the first B plank over the short side of the first A plank, align the edge using the tongue of a spare or scrap plank. It is important for precise alignment of edges for a good, square installation. Tap the top of the B plank using a soft-faced hammer to fully lock the planks together.
5. Start the First Column - Slide your V up to the starting wall, making sure you are aligned on your working lines. The inside corner of your V as well as the bottom point of the plank should be on the right working line. The outside corner or joint should be aligned on your left working line. Place spacer between the wall and Plank A. Notice that plank A is the only plank that is against the wall - this is normal.
6. Continue with the First Column - Continue to install A & B planks, one after the other, until you complete the first column of your room. Continue to use your scrap plank to keep alignment. It is important when installing to start tapping down where the A and B planks cross, tapping your way out. Do not tap down the last 2 inches of the long sides. This will be tapped down when installing the next columns. Make sure you continue to keep your column straight on your working lines. Adjust as necessary.
7. Finish First Column - When you cannot install anymore full planks, you are finished with the center column. You will install the cut planks at the end of the installation.
8. Connect Planks to the Left and Right of the Center Column - Starting with the last full planks installed, connect A planks to B planks by lifting the untapped edge and sliding the planks under. Make sure the tongue and groove are precisely aligned and tap down joints to lock. Remember, do not tap down the last two inches of the planks in your next columns.

INSTALLATION (CONT):

9. Continue Connecting to the Left and Right Side - Continue the installation on both sides of the center column (connect A planks to B planks and B planks to A planks) working back towards the starting wall.
10. Install the Remaining Columns - Continue forming columns back and forth until you reach the outside walls and cannot install anymore full planks. Make sure your pattern continues to stay straight on your center column working lines. Once final cut pieces are placed, you will not be able to adjust the installation.
 - Note: If you need to remove a plank for whatever reason, gently push down on the plank with the groove while lifting the plank with the tongue. Be careful not to damage the tongue and groove. Tap down lightly on the plank with the groove if necessary. your next columns.
11. Connect More Planks to the Left and Right Side of the Center Column - Measure, mark, and cut final planks to fit to the wall leaving the required ¼" (6mm) expansion space. A T-Bevel can be used to find the correct angle. When fitting small cut pieces, a scant bead of Prevail 30GS can be applied to the groove to make sure product stays in place.
 - Note: Do not discard planks cut on angles. They may be used in other areas of the installation if layout per-mits. Stack in accordance of A and B planks.
12. Finish the Job - Remove spacers. Cover expansion space with quarter round or other trim, being sure not to trap or pin down the floor.

INSTALLATION (CONT):

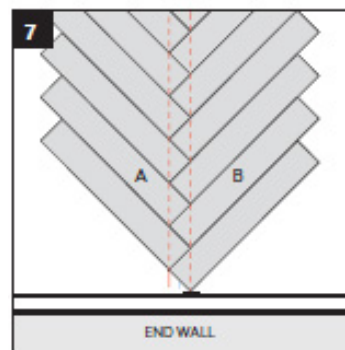
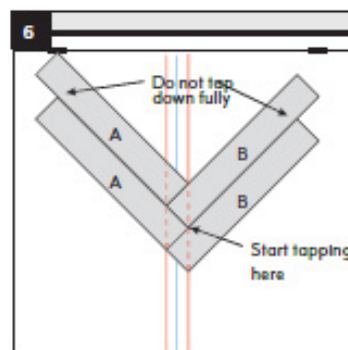
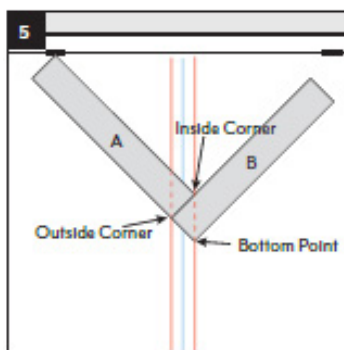
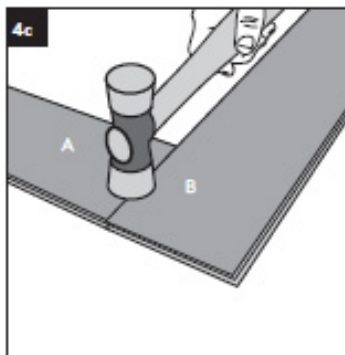
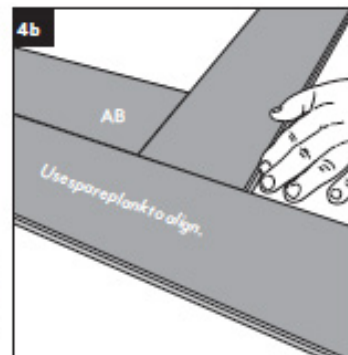
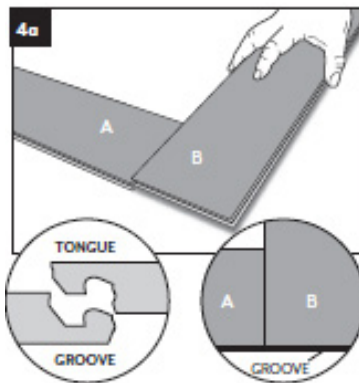
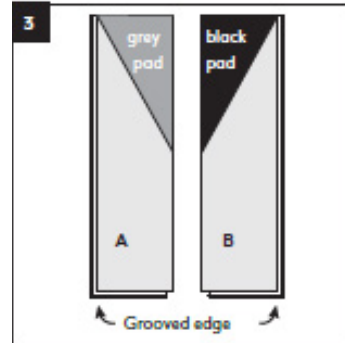
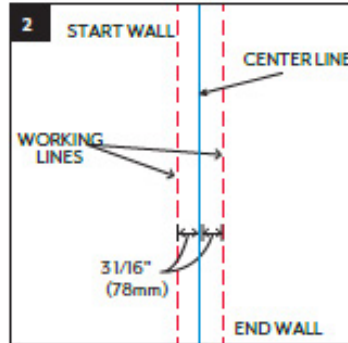
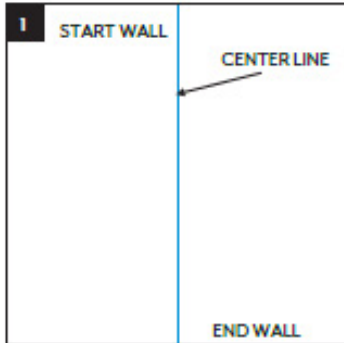

INSTALLATION (CONT):

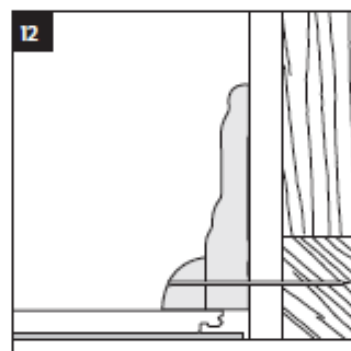
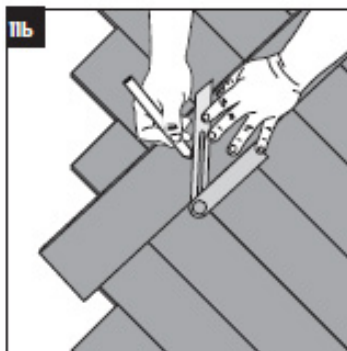
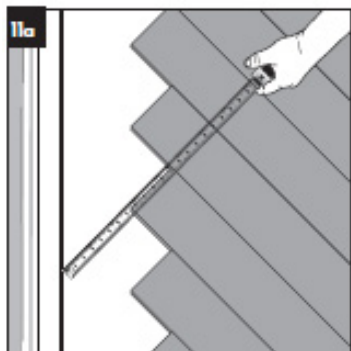
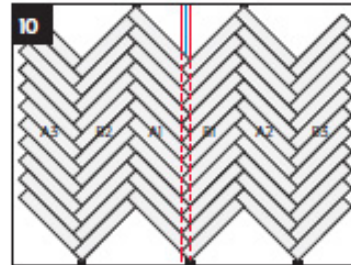
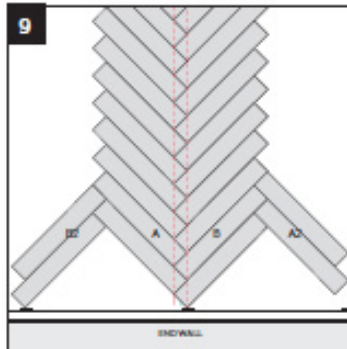
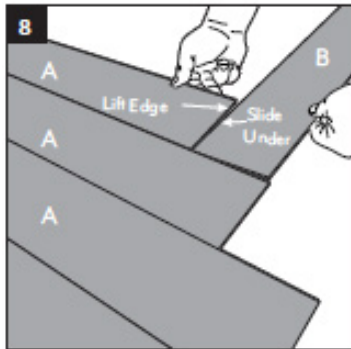

ROUTINE CARE & MAINTENANCE:

- Sweep, dust mop or vacuum daily. Do not use vacuums with any type of beater bar assembly.
- Lightly damp mop with Prevail™ Neutral Cleaner. Remove excess soil by carefully scrubbing with a soft nylon brush or magic eraser sponge and Prevail Neutral Cleaner.
- Remove scuffs using Prevail Neutral Cleaner and a soft nylon brush or magic eraser sponge.
- Heavily soiled floors may require an occasional deep cleaning using Prevail Neutral Cleaner, spray bottle and a low-speed buffer not exceeding 175 RPM. Fit the buffer with a red or white scrubbing pad, spray the cleaner solution onto a manageable area of the floor and scrub. Remove the dirty residue by damp mopping with clear water. Caution: Do not flood the floor.
- Remove standing water, pet urine and other liquids promptly. Follow with Prevail 1-Step Neutral Cleaner or Prevail Ready to Use Neutral Cleaner.

PREVENTIVE CARE:

- Use non-staining walk-off mats at all outside entrances.
- Use flat glides at least 2" (50mm) in diameter under furniture legs or free standing displays and fixtures to prevent indentations and scratches.
- Use broad surface non-staining casters at least 2" (50mm) in diameter on rolling fixtures or furniture.
- Do not use vinegar, polishes, waxes, oil soaps, abrasive cleaners, harsh detergents, "mop and shine" products or solvents.
- Do not expose to direct sunlight for prolonged periods.
- Do not use steam cleaners.
- Do not flood floor or subject to standing liquids, including pet urine.

NOTES: Stain Removal – To remove stubborn spots and stains from QuietLok® floors, always begin with mild cleaners, such as Prevail 1-Step Neutral Cleaner. If such cleaners fail to remove the spots and stains, and "if permitted," use mineral spirits. Do not use harsh solvents, such as lacquer thinner or straight acetone, as these can permanently soften and damage the vinyl surface. For stubborn spots and stains (such as paints, permanent markers, and dyes), and "if permitted," try applying fingernail polish remover containing acetone (do not use straight acetone) to a soft cloth and rubbing across the affected areas. Subsequent to this cleaning procedure for stubborn spots and stains, please clean the affected area with clear water to remove any residue. Any damage resulting from the use of pure solvents IS NOT covered by the QuietLok® Warranty. Always test stronger cleaning agents on sample pieces or in unnoticeable areas, first. Never use a brush or pad more aggressive than a 3M red equivalent. Blue, Green, Brown and Black pads will damage the surface of the floor.